

ASSEMBLY INSTRUCTION

KB-12118

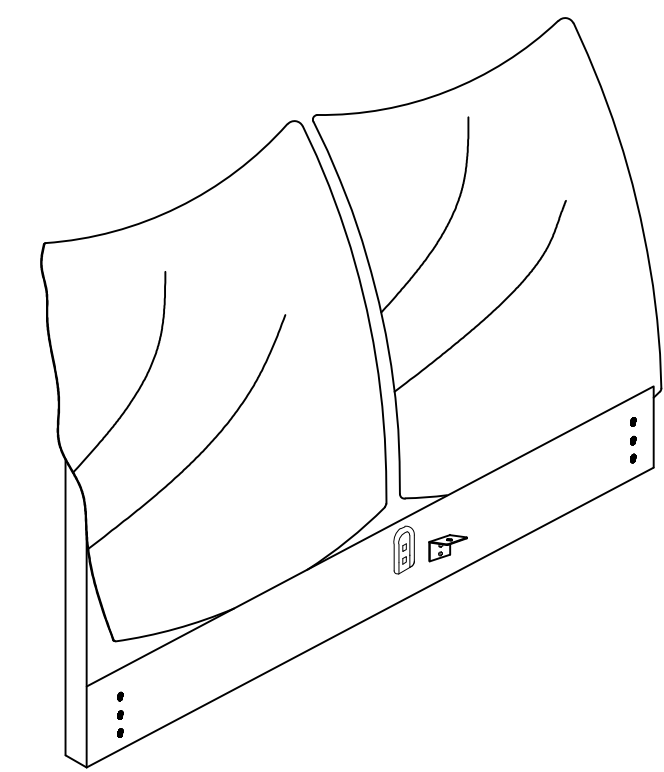

A HEADBOARD=1PC

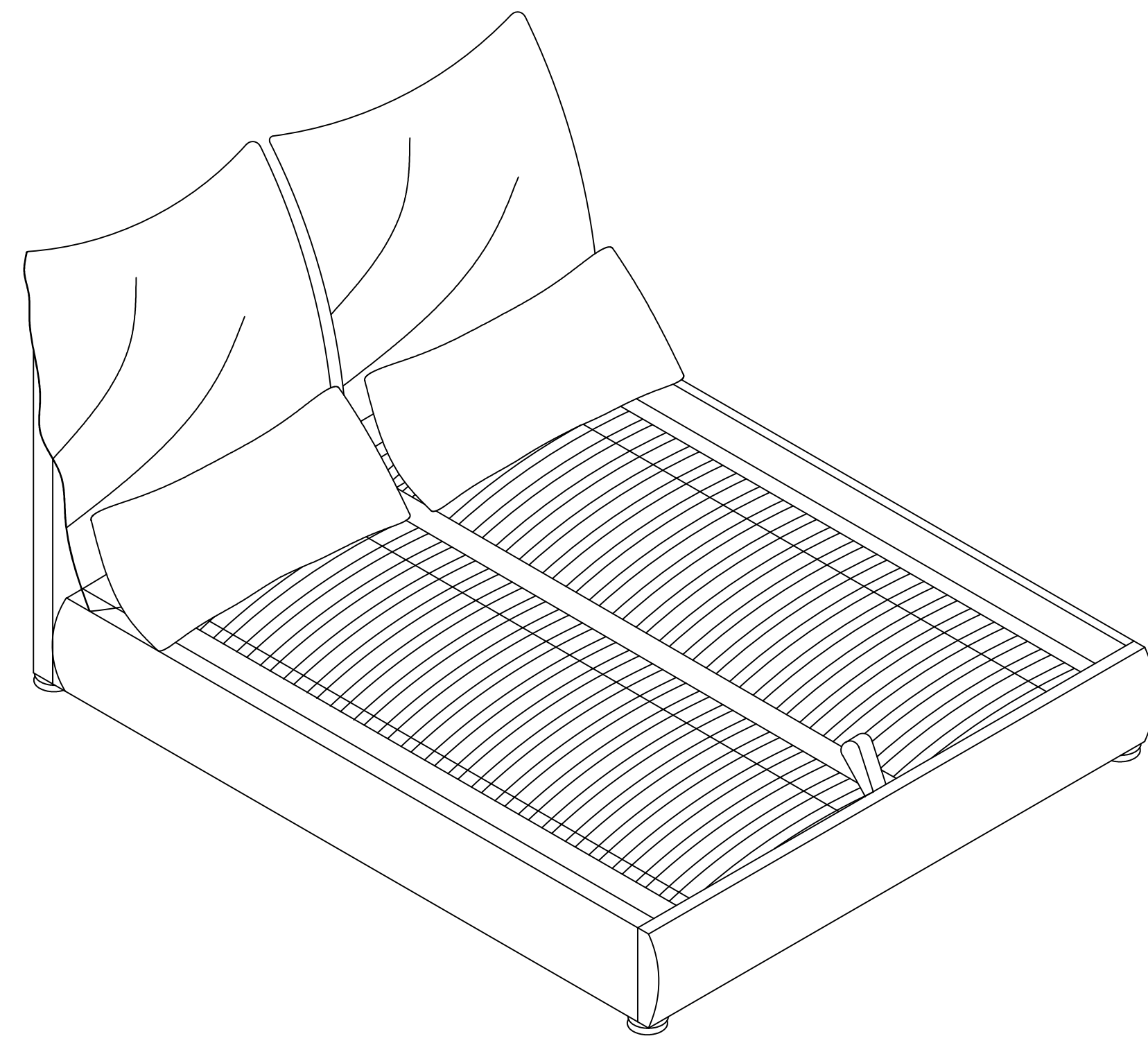
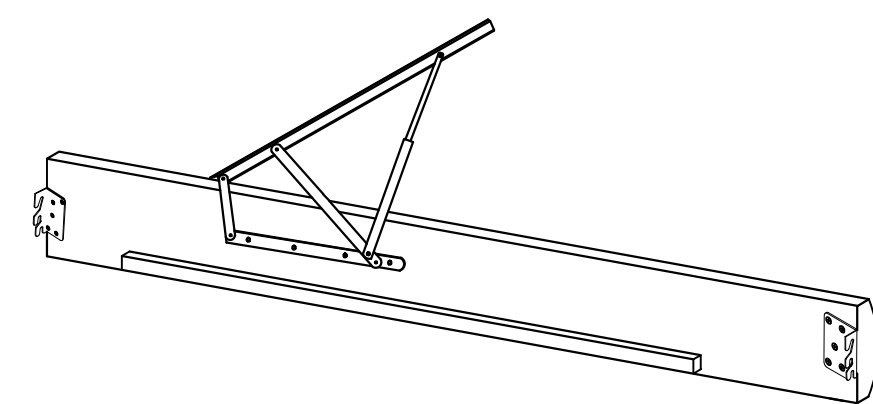

B SIDE RAIL=2PCS

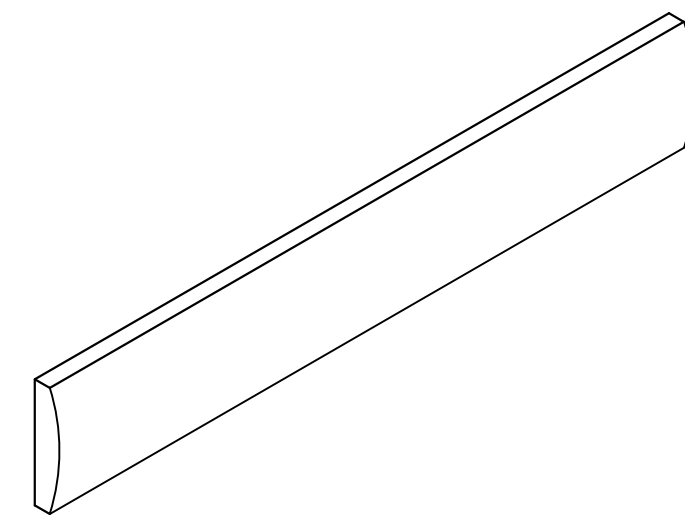

C FOOTBOARD=1PC

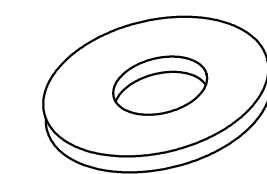

D WASHER
5/16=44PCS

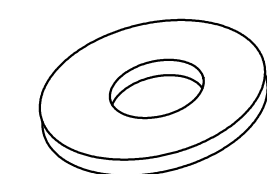

E WASHER
1/4=8PCS

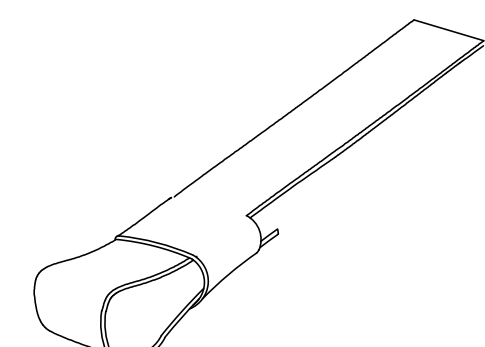

F HANDLE=1PC

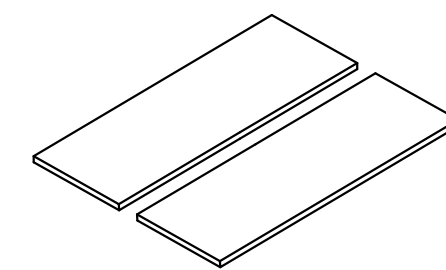

G BASE BOARDS=2PCS

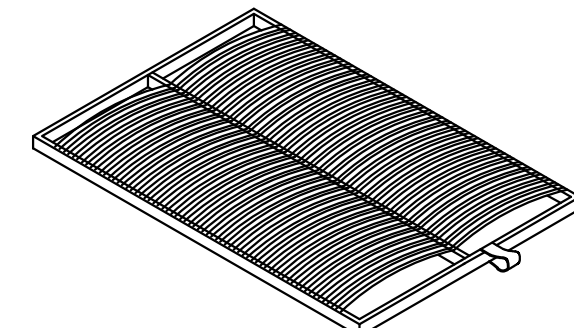

H SLATS=1PC

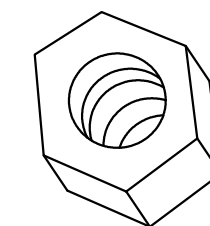

I NUT
1/4=4PCS

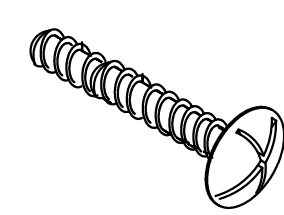

J BOLT
1/4X45mm=4PCS

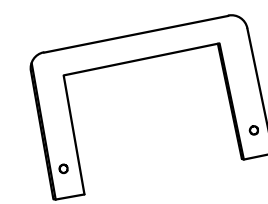

K METAL MATTRESS
SUPPORT=2PCS

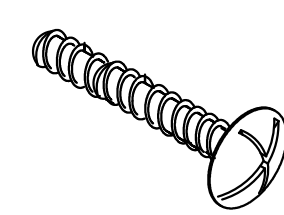

L BOLT
5/16X45mm=14PCS

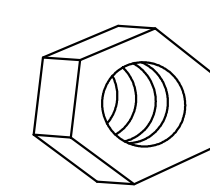

M NUT
5/16=16PCS

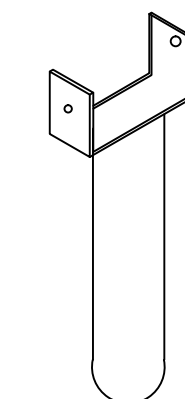

N FEET=2PCS

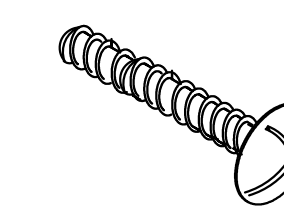

O BOLT
5/16X75mm=2PCS

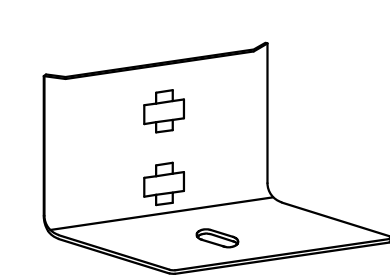

P CAPE CODE=4PCS

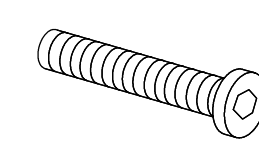

Q BOLT
5/16X35mm=12PCS

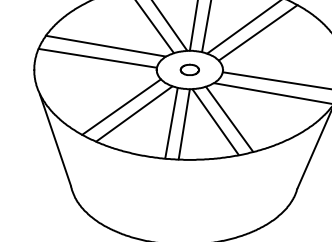

R WOOD FEET=4 PCS

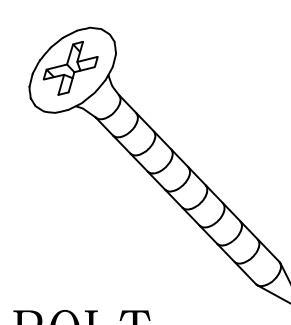

S BOLT
5/16"X35mm=4PCS

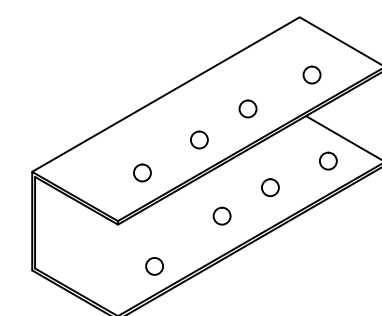

T CAPE CODE=2PCS

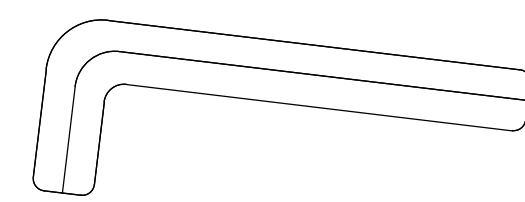

U Allen Wrench M5=1件

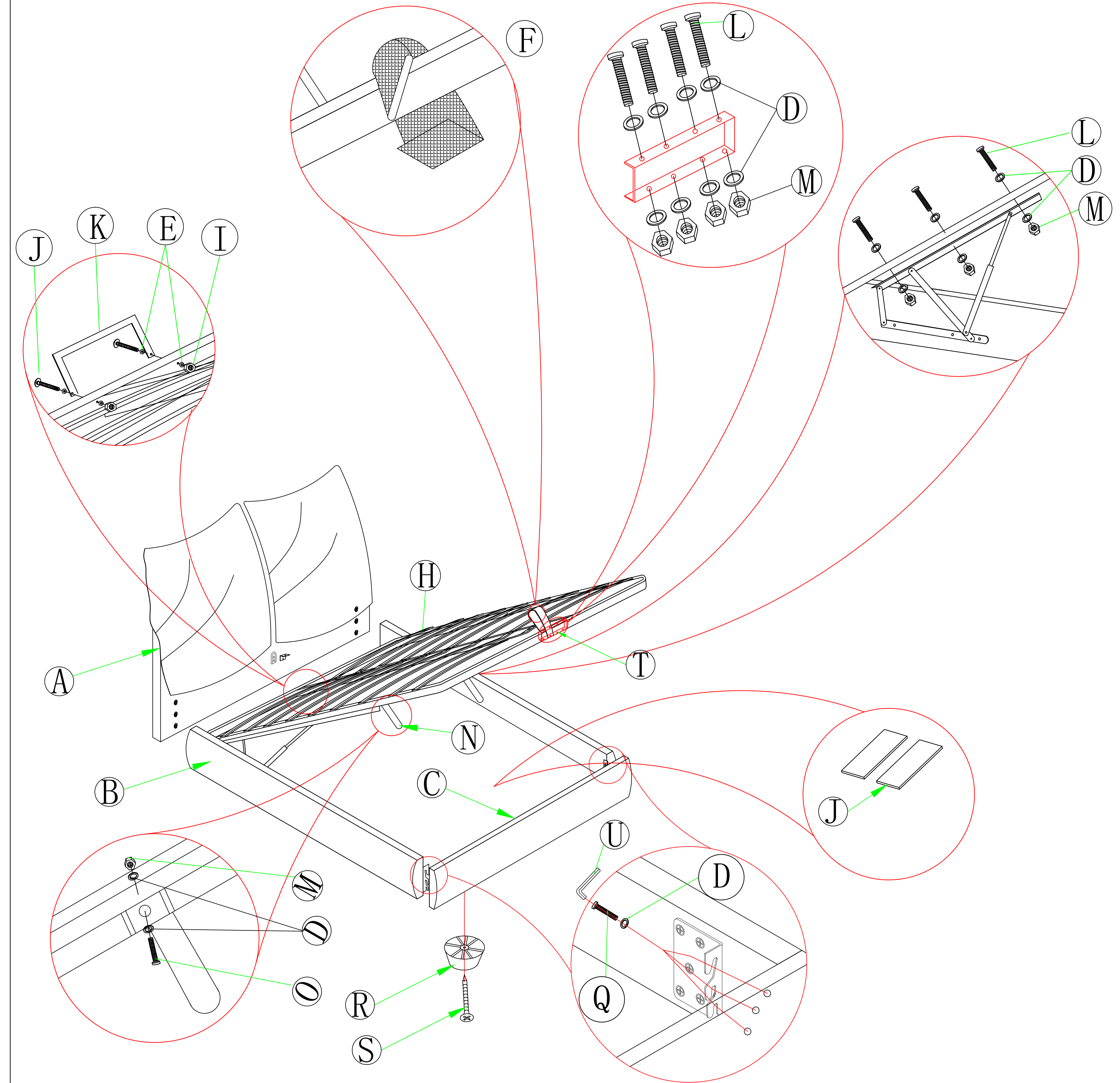

ASSEMBLY INSTRUCTIONS:

- 1.SLIDE THE HOOKS ON THE SIDE RAILS (B) INTO THE SLOTS LOCATED HEADBOARD (A) AND FOOTBOARD (C).
PRESS DOWN UNTING THEY CLICK TO SECURE"
- 2.SCREW THE BRACKET (P) ONTO THE CENTRE BY BOLT (S).
- 3.PUT THE PLASTIC FEET (E) ONTO THE CENTRE (D) BY BOLTS (Q).
- 4.CONNECT THE CENTRE SUPPORT RAIL (D) TO THE HEADBOARD (A) AND FOOTBOARD (C) .
- 5.ATTACHED THE SUPPORT BRACKET (P) TO THE HEADBOARD AND FOOTBOARD.
- 6.PUT IN THE BASE BOARDS (I).
- 7.CONNECT THE METAL MATTRESS HOLDER (M) TO THE FRAME USING BOLTS (L) AND WASHER (R) AND NUTS (K).
- 8.EXTEND THE MECHANISM UPWARDS AND SECURE THE METAL SLAT FRAME (J) ONTO IN BY SCREW (N) AND NUTS (O) AND WASHER (G). ENSURE THE METAL SLAT FRAME IS CORRECTLY ALIGNED TO FIT INSIDE THE BED,BEFORE TIGHENING THE SCREWS.
- 9.ONLY LIFT THE BED FRAME WHEN A MATTRESS IS IN POSITION.